



||LO3 LED STREET LIGHT
20W-230W

100+ Patent Certificates
\$1,000,000+ Annual Energy Saving
10,000+ Projects Successfully Installed





OVER YEARS 
10 EXPERIENCE
www.aokledlight.com

> Features of IL03 Series

IL03 series is an economical energy-saving and flexible application scenarios street light/area light with high-cost performance.

- Power range: from 20W to 230W.
- Streamlined fixture body design, industrial-level design standards.
- Micro-lens systems produce IESNA Type II, Type III, Type IV and Type V distributions.
- Luminaries produces 0% total lumens above 90° (BUG Rating, U=0), provides uniform light output with a lower glare.
- Optical systems maintain an IP66 rating.
- The top spot of the fixture is reserved for the sensor in the case of future installation.
- Worry-free installation, easy maintenance.

	UP TO 145 lm/W	L90B10 >52000hrs @ 25°C	100-277V 50/60HZ	THD <20%
2700K 3000K 4000K 5000K 5700K 6500K	CRI 70/80/90	ULR =0		DIM
Working Temperature Environment -40°C~50°C (-40°F~+122°F)	IP66 IK09	3G VIBRATION TESTING		



**Illuminate
Your
Future**

5 **10** **WARRANTY**
5 Year Limited Warranty,
10 Year Preferred Warranty.
Please consult with our sales for detailed agreement.

wally@akledlight.com
+1 626-986-4050 (US)
+86 755 2357 9148 (CN)
©2022 AOK LED LIGHT CO., LTD. All Right Reserved.



> Photometric Design

- Optimized, premium optical grade Mitsubishi polycarbonate lens, the efficient design of the modules make each light engine highly customizable, allowing the light distribution to be aimed toward the application.
- Optical systems allow for versatility, tight cutoffs, and flexible control for a wide variety of applications.
- We deliver innovation and customization, further expanding the flexibility of the project. Exceptional uniformity and low glare for maximum comfort and neighbor-friendly.

Distribution Type

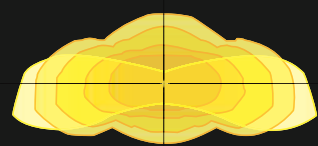

TYPE II (T201)

Asymmetric, Type II can be used in long and narrow aisles/lanes/sidewalks.

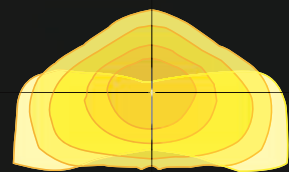

TYPE III (T301)

Asymmetric, Type III can be used in wide road parking areas, or at corner areas.

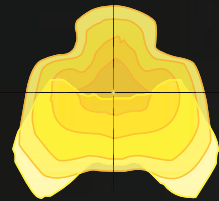

TYPE IV (T401)

Asymmetric, Type IV can be used in wide road parking areas, or at corner areas.

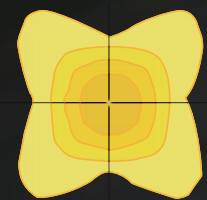

TYPE V (T501)

Symmetrical, T5 is suitable for use in the central area of the car park, or in road intersection areas.

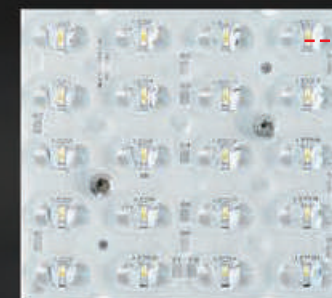

Lumileds 3030 LED chip

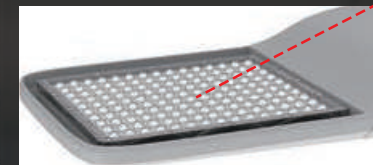

The photometric engine takes advantage of the latest generation of mid-power LEDs and dedicated optics for professional applications. Combined with Lumileds 3030 it provides an alternative solution for those who are looking for very cost-effective yet efficient lighting while keeping the same luminaire design.

> Control Systems

Custom Dimming Profile

Intelligent luminaire drivers can be programmed with complex dimming profiles. With customized combinations of time intervals and light levels are possible. This feature does not require any extra wiring.

The period between switching on and switching off is used to activate the preset dimming profile. The customised dimming system generates maximum energy savings while respecting the required lighting levels and uniformity throughout the night.

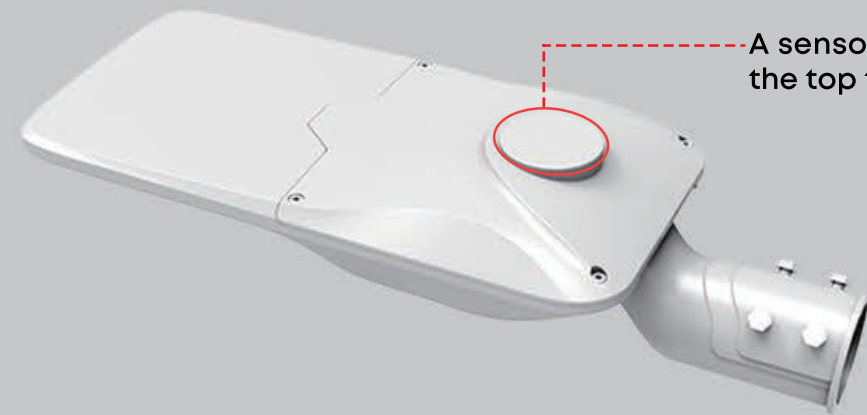
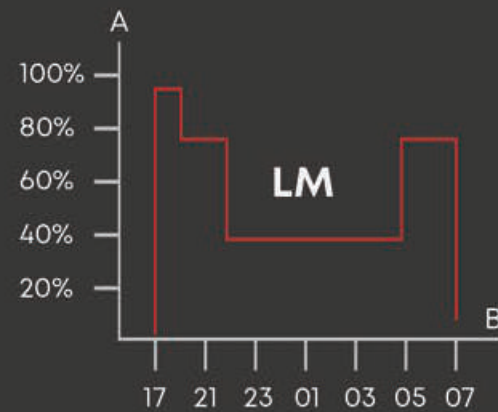

A sensor mounting hole is reserved on the top to facilitate future installation.



Daylight Sensor / Photocell

Photocell or daylight sensors switch the luminaire on as soon natural light falls to a certain level. It can be programmed to switch on during a storm, on a cloudy day (in critical areas) or only at nightfall so as to provide safety and comfort in public spaces.



Smart standards. Smarter lighting.

LoRaWAN® Luminaire Controller Zhaga (Optional)

It is an easily installable wireless device for remote control of the LED luminaires. Device is equipped with Zhaga compliant connector and controls the luminaire through DALI or DALI-2 interface. Controller is available now for LoRaWAN®, NB-IoT and LTE-M network. Modern and small design makes it excellent fit to various street lighting modules.

LoRaWAN® Luminaire Controller NEMA (Optional)

LoRaWAN® Luminaire Controller NEMA is a remote control device for LED luminaires equipped with ANSI C136.41 NEMA receptacle. The luminaire is controlled through DALI or 0..10V analog control interfaces, while providing a reliable power interconnect with three robust twist lock contacts.

► Application Reference

- Urban & residential streets
- Bridges
- Bike & pedestrian paths
- Railway stations & metros
- Car parks
- Squares & pedestrian areas
- Roads & motorways



Parameter Table

Electrical Data

Model	AOK-20WiL03	AOK-30WiL03	AOK-50WiL03	AOK-60WiL03	AOK-70WiL03	AOK-80WiL03
Power(W)	20 W	30 W	50 W	60 W	70 W	80 W
Input voltage	100-277VAC					
THD	<20%					
PF	≥0.95	≥0.95	≥0.95	≥0.98	≥0.98	≥0.98
Driver	Meanwell / Sosen / Philips. Class 1/ Class 2, EU					
Operating temperature	-40°C to 50°C (-40 °F to 122 °F)					
Control Option	Surge Protective Device、Daylight Sensor Control、1-10V Dimming					
Surge Protection	10kV / 20kV optional					

Photometric Data

Efficacy(lm/W) (CRI 70Ra, 5000K) (Std Dev ±3%)	T2	145lm/W	145lm/W	140lm/W	135lm/W	140lm/W	135lm/W
	T3	145lm/W	145lm/W	140lm/W	135lm/W	140lm/W	135lm/W
	T4	145lm/W	145lm/W	140lm/W	135lm/W	140lm/W	135lm/W
	T5	145lm/W	145lm/W	140lm/W	135lm/W	140lm/W	135lm/W
	T2	2900lm	4350lm	7000lm	8100lm	9800lm	10800lm
Luminous flux (lm) (CRI 70Ra, 5000K) (Std Dev ±3%)	T3	2900lm	4350lm	7000lm	8100lm	9800lm	10800lm
	T4	2900lm	4350lm	7000lm	8100lm	9800lm	10800lm
	T5	2900lm	4350lm	7000lm	8100lm	9800lm	10800lm
	ULR = 0%, @ Luminaire inclination 0°						
	CCT 2700K, 3000K, 4000K, 5000K, 5700K, 6500K						
CRI 70Ra, 80Ra, 90Ra optional							
Beam angle T2/T3/T4/T5							
LED Manufacturer LUMILEDS							
LED model Lumileds 3030							
Working current of single LED (mA)	T2	40mA	60mA	100mA	120mA	90mA	110mA
	T3	40mA	60mA	100mA	120mA	90mA	110mA
	T4	40mA	60mA	100mA	120mA	90mA	110mA
	T5	40mA	60mA	100mA	120mA	90mA	110mA
	Lens Polycarbonate						

Mechanical Data

IP/IK	IP66/IK09, according to standard EN 60529 and EN 62262					
Vibration resistance	3G, conform to standard IEC 68-2-6.					
EPA(SCx)	Front: 1.32ft² (0.122632m²); Side: 0.34ft² (0.031587m²);					
Materials	Heavy-duty die-cast aluminum (EN AC-46100)					
Painting	Black, Silver, Custom request					
Surface treatment	Anti-UV thermosetting polyester / 80 micron epoxy primer + Anti-UV thermosetting polyester (for extremely corrosive environments).					
Cable	Pre-wired with a 30 cm cable (Other lengths on request)					
Mounting	Side entry					
Others						
Lifespan	L90B10 > 52000 hrs, @Ta 25°C					
Warranty	5 years (Warranty extension up to 10 years on request)					
Product size	21.7*8.43*5.35" / 551*214*136mm					
Carton size	24.21*10.43*8.27" / 615*265*210mm					
Net weight	3.1kg	3.1kg	3.1kg	3.1kg	3.1kg	3.8kg
Gross weight	4.3kg	4.3kg	4.3kg	4.3kg	4.3kg	5kg
Recommend installation height	General 4-12m, based on actual project requirements					
Application field	Urban and rural street					

Electrical Data

Model	AOK-100WiL03	AOK-120WiL03	AOK-150WiL03	AOK-180WiL03	AOK-200WiL03	AOK-230WiL03
Power(W)	100 W	120 W	150 W	180 W	200 W	230 W
Input voltage	100-277VAC					
THD	<20%					
PF	≥0.98	≥0.98	≥0.98	≥0.98	≥0.98	≥0.98
Driver	Meanwell / Sosen / Philips. Class 1/ Class 2, EU					
Operating temperature	-40°C to 50°C (-40 °F to 122 °F)					
Control Option	Surge Protective Device、Daylight Sensor Control、1-10V Dimming					
Surge Protection	10kV / 20kV optional					

Photometric Data

Efficacy(lm/W) (CRI 70Ra, 5000K) (Std Dev ±3%)	T2	135lm/W	135lm/W	135lm/W	140lm/W	135lm/W	135lm/W
	T3	135lm/W	135lm/W	135lm/W	140lm/W	135lm/W	135lm/W
	T4	135lm/W	135lm/W	135lm/W	140lm/W	135lm/W	135lm/W
	T5	135lm/W	135lm/W	135lm/W	140lm/W	135lm/W	135lm/W
	T2	13500lm	16200lm	20250lm	25200lm	27000lm	31050lm
Luminous flux (lm) (CRI 70Ra, 5000K) (Std Dev ±3%)	T3	13500lm	16200lm	20250lm	25200lm	27000lm	31050lm
	T4	13500lm	16200lm	20250lm	25200lm	27000lm	31050lm
	T5	13500lm	16200lm	20250lm	25200lm	27000lm	31050lm
	ULR = 0%, @ Luminaire inclination 0°						
	CCT 2700K, 3000K, 4000K, 5000K, 5700K, 6500K						
CRI 70Ra, 80Ra, 90Ra optional							
Beam angle T2/T3/T4/T5							
LED Manufacturer LUMILEDS							
LED model Lumileds 3030							
Working current of single LED (mA)	T2	135mA	115mA	145mA	120mA	135mA	150mA
	T3	135mA	115mA	145mA	120mA	135mA	150mA
	T4	135mA	115mA	145mA	120mA	135mA	150mA
	T5	135mA	115mA	145mA	120mA	135mA	150mA
	Lens Polycarbonate						

Mechanical Data

IP/IK	IP66/IK09, according to standard EN 60529 and EN 62262					
Vibration resistance	3G, conform to standard IEC 68-2-6.					
SCx	Front: 1.32ft² (0.122632m²); Side: 0.34ft² (0.031587m²);	Front: 1.77ft² (0.164438m²); Side: 0.37ft² (0.034374m²);	Front: 2.15ft² (0.2m²); Side: 0.44ft² (0.0413m²);			
Materials	Heavy-duty die-cast aluminum (EN AC-46100)					
Painting	Black, Silver, Custom request					
Surface treatment	Anti-UV thermosetting polyester / 80 micron epoxy primer + Anti-UV thermosetting polyester (for extremely corrosive environments).					
Cable	Pre-wired with a 30 cm cable (Other lengths on request)					
Mounting	Side entry					
Others						
Lifespan	L90B10 > 52000 hrs, @Ta 25°C					
Warranty	5 years (Warranty extension up to 10 years on request)					
Product size	21.7*8.43*5.35" / 551*214*136mm	24.45*10*5.35" / 621*254*136mm	29.76*12.13*5.43" / 756*308*138mm			
Carton size	24.21*10.43*8.27" / 615*265*210mm	26.97*12*8.27" / 685*305*210mm	32.48*14.17*8.07" / 825*360*205mm			
Net weight	3.8kg	4kg	4kg	5.6kg	5.6kg	5.6kg
Gross weight	5kg	5.5kg	5.5kg	6.9kg	6.9kg	6.9kg
Recommend installation height	General 4-12m, based on actual project requirements					
Application field	Urban and rural street					

IL03 Series Specification Sheet

*Due to the constant improvements in product development, individual parameters might change. Please refer to our sales or R&D team for most up-to-date content as specifications are subject to change without notice.

wally@aokledlight.com
+1 626-986-4050 (US)
+86 755 2357 9148 (CN)

©2022 AOK LED LIGHT CO., LTD. All Right Reserved.



Ordering Information

AOK								
WATTS	VOLTAGE	LED CHIPS	TYPE OF SENSOR	CCT&CRI	DISTRIBUTION	MOUNT	HOUSING	OPTIONS
20WiL03	NV=100-277V	L3=LUMILEDS 3030	00=Without Sensor	2770=2700K 70CRI	T2=Type II	A=Side Entry	SG=Silver Gray	10KV SPD
30WiL03			PH=Photocell	3070=3000K 70CRI	T3=Type III		BK=Black	20KV SPD
50WiL03			DV=Dimmable	4070=4000K 70CRI	T4=Type IV			
60WiL03				5070=5000K 70CRI	T5=Type V			
70WiL03				5770=5700K 70CRI				
80WiL03				6570=6500K 70CRI				
100WiL03				2780=2700K 80CRI				
120WiL03				3080=3000K 80CRI				
150WiL03				4080=4000K 80CRI				
180WiL03				5080=5000K 80CRI				
200WiL03				5780=5700K 80CRI				
230WiL03				6580=6500K 80CRI				

Illuminance Diagram

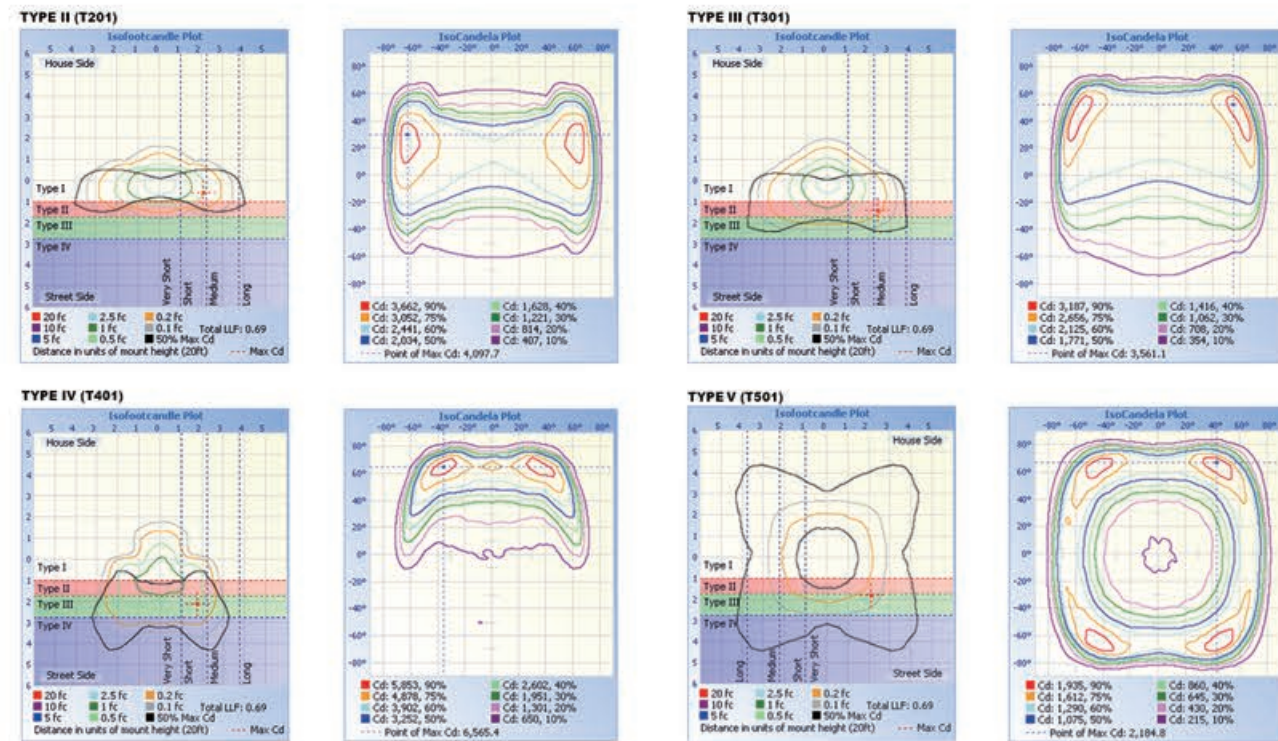

Accessories



*As the products are upgraded, the accessories may differ from those described in the pictures. Please consult with our sales team for updated details and order separately.

Construction Features

Electrical

- Driver Efficiency: >86%~>93%; Maximum Current: AC0.22 A (max)~AC2.5 A (max)
- 1-10V/ PWM/ Timer dimming, 3 Timer Modes, Dim-to-Off with standby power <= 0.5W.
- Constant current Class I driver, 100-277Vac, 50-60Hz, Class II optional.
- High efficiency driver: PF>0.95, driver efficiency >92%.
- Input Surge Protection: 6kV line-line, 10kV line-earth, 20KV SPD available.
- Operating temperature rating: -40° F to 122° F (-40° C to 50° C).
- Compatible with DALI, Zhaga / Nema standards, Presence detection sensor.

Construction

- Robust die-cast aluminum housing.
- UV stabilized polyester powder paint finish for durability and corrosion resistance.
- Side entry installation.
- Uniform luminous flux and low glare design.
- IP66 & IK09.
- 3G vibration rating.

Dimension



20W-100W

120W-150W

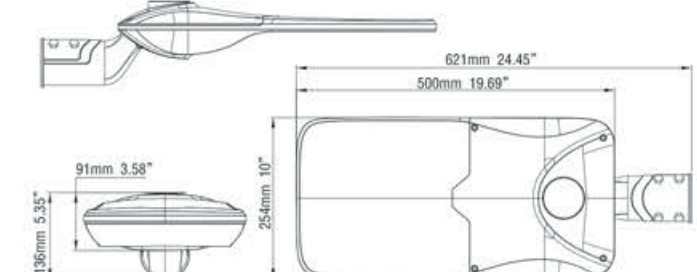
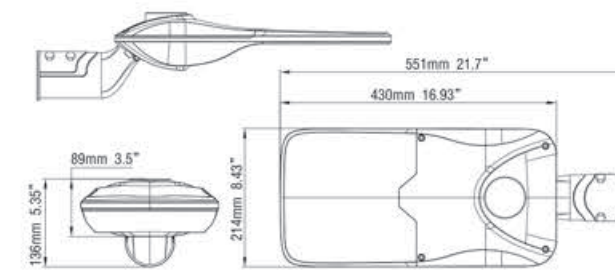

180W-230W

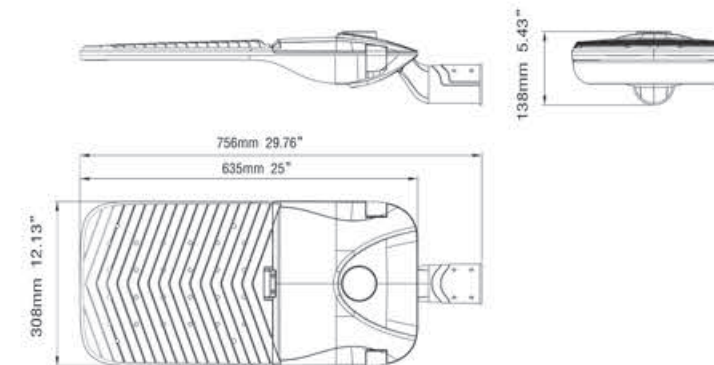

IL03 Series Specification Sheet

*Due to the constant improvements in product development, individual parameters might change. Please refer to our sales or R&D team for most up-to-date content as specifications are subject to change without notice.

wally@ookledlight.com
+1 626-986-4050 (US)
+86 755 2357 9148 (CN)

©2022 AOK LED LIGHT CO., LTD. All Right Reserved.





Illuminate Your Future

5 **10** ● WARRANTY
5 Year Limited Warranty,
10 Year Preferred Warranty.
Please consult with our sales for detailed agreement.

wally@aokledlight.com
www.aokledlight.com
+1 626-986-4050 (US)
+86 755 2357 9148 (CN)

Manufacturing: Building 1 & 4, St. George's Science and Technology Industrial Park, Shajing Street, Shenzhen, China, 518124.
Fuzhou HQ: Room 301, Yujing Business Center Zone 1, No. 12 Baihuazhou road, Cangshan district, Fuzhou, China, 350007
NorthAmerica HQ: 18541 E Gale Ave, City of Industry, CA91748 USA

Copyright ©2022 AOK LED LIGHT CO., LTD. All Right Reserved.